

locktronicsTM

Simplifying Electricity

Fundamentals of Electricity

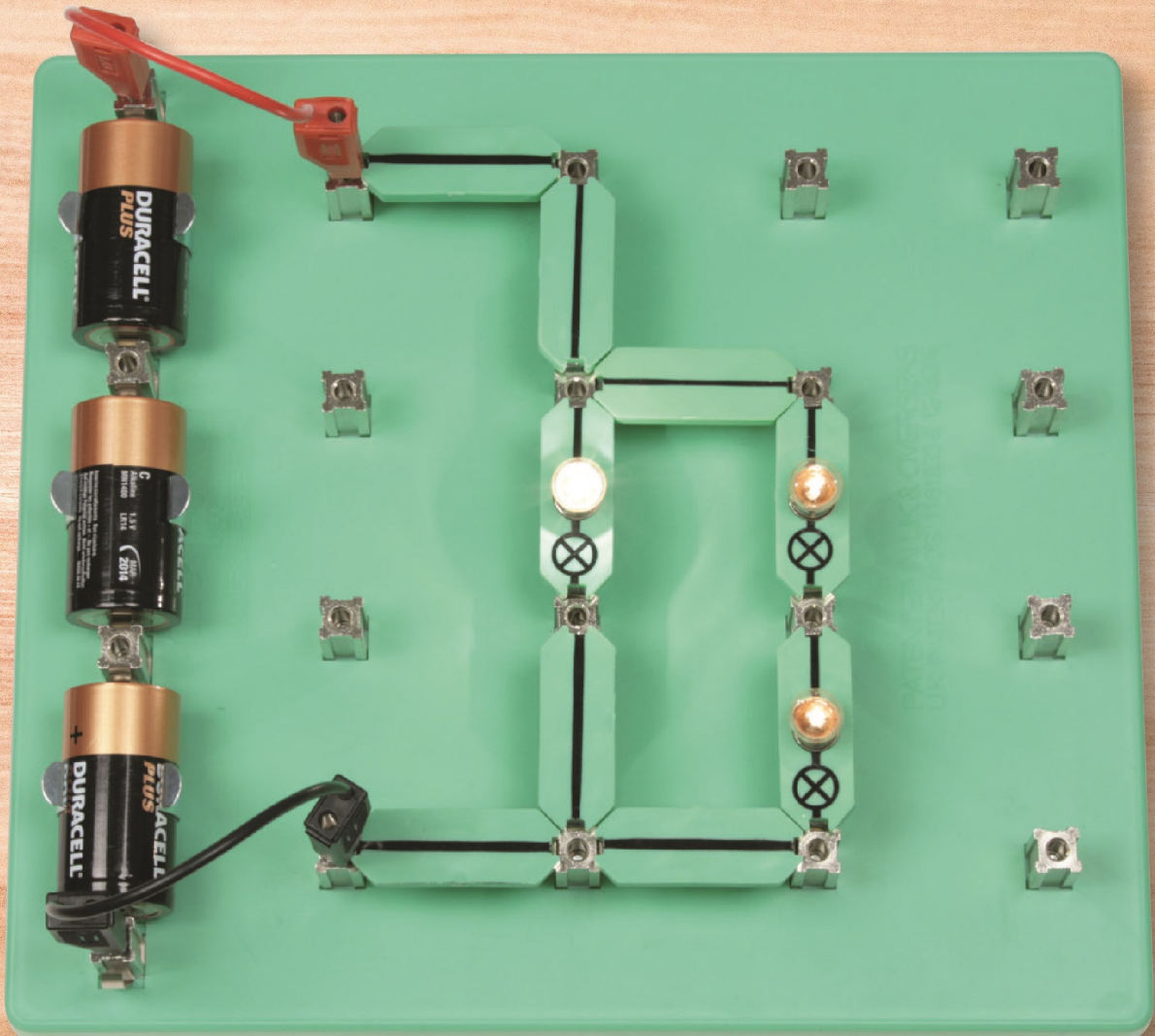

MATRIX

CP6816

www.matrixtsl.com

Copyright © 2023 Matrix Technology Solutions Limited

Worksheet 1 - Which things use electricity	3
Worksheet 2 - Types of electricity	4
Worksheet 3 - Electricity can be dangerous	5
Worksheet 4 - Making a circuit	6
Worksheet 5 - A complete circuit	7
Worksheet 6 – Batteries	9
Worksheet 7 - Buzzers	10
Worksheet 8 - Motors	11
Worksheet 9 - Conductors	12
Worksheet 10 - Conductors and Insulators	13
Worksheet 11 - Switches	14
Worksheet 12 - Components in a circuit	15
Worksheet 13 - Circuit symbols	16
Worksheet 14 - Circuit diagrams	17
Worksheet 15 - Types of circuit	18
Worksheet 16 - Electricity	19
Worksheet 17 - Understanding circuits	20
Teachers Notes	21

Worksheet 1

Which things use Electricity?

Many of the things we use every day at home and at school need electricity to make them work.

Some of those things will plug into a mains socket in the wall and other things will use electricity stored in batteries.

This kettle has to be plugged into a mains socket to get enough electricity to heat the water. . .



. . . but this TV remote has batteries that store enough electricity to allow you to change channels.



Electricity can make things produce heat energy, light energy, sound energy or move about.

Activity

1. Look at the pictures below and make a list of the devices that use electricity and another list of the ones that don't



2. Which ones use electricity to make heat and light energy and which ones use electricity to make sound energy or move about?

Worksheet 2

Types of Electricity

There are two different types of electricity.



1. Natural electricity such as lightning during storms and the static electricity which can be created by rubbing balloons and some jumpers.



2. Artificial electricity as stored chemically in batteries or produced in huge power stations using generators. All types of electricity can be dangerous!

All types of electricity can be dangerous!

Activity:

1. Use a computer and the internet to find out as much as you can about lightning.
2. Type up or write down 5 or more interesting things that you have learnt and give your work a title.
3. Can you find a good picture to go with your work?

Your computer needs electricity to make it work. Most computers are plugged into the mains but laptops usually also have batteries that need to be charged up.

Activity:

1. Make a list of 5 other things in your classroom or at home that use electricity.
2. For each one describe if it needs to be plugged in or if it uses batteries.
3. Explain how each one uses electricity to make it work. Does it get hot, or make a sound for example

Electricity can be dangerous

Electricity is very powerful and if it is not used properly then it can be very dangerous.

Natural electricity like lightning has always existed, however it is very difficult to predict or control, making it almost impossible to use and very dangerous.

Electricity from the mains sockets in buildings is generated at huge power stations and can also be very dangerous. You should always be careful when using batteries, however you should be extremely careful when using electricity from the mains.

A battery is like a kitten that could scratch you if it gets angry. Mains electricity is like a wild Lion that could do much more damage if you made it angry! They are both cats but one is much more dangerous than the other. Batteries and mains electricity are both forms of electricity but mains electricity, like the Lion, is much more dangerous.

Whenever Electricity could be dangerous you will see warning signs like this one.

“Danger - High Voltage”

Activity:

Think about where you have seen electricity warning signs and what the dangers have been. Design your own warning sign to let people know that electricity can be dangerous. Think about the colors and symbols that are normally used and why?

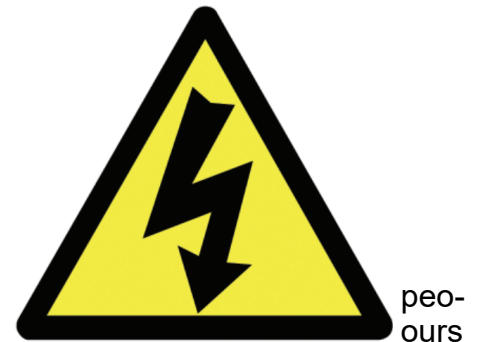

Here are a few safety rules to help keep us safe. Can you fill in the blanks?

- Switch _____ before plugging and un-plugging appliances.
- Plugs should not be touched with _____ hands.
- Stay away from outdoor _____ lines and transformers.
- Never fly a _____ near overhead wires.
- Never try to cut open a battery or put one in your mouth. Batteries contain _____ that are poisonous.

chemicals

wet

kite

off

power

Worksheet 4

Making a circuit

A circuit needs a source of electricity to work and so we can use a battery. A battery has negative and positive ends (called poles). A connection needs to be made at either end of the battery to allow electricity to flow around the circuit and make it work.

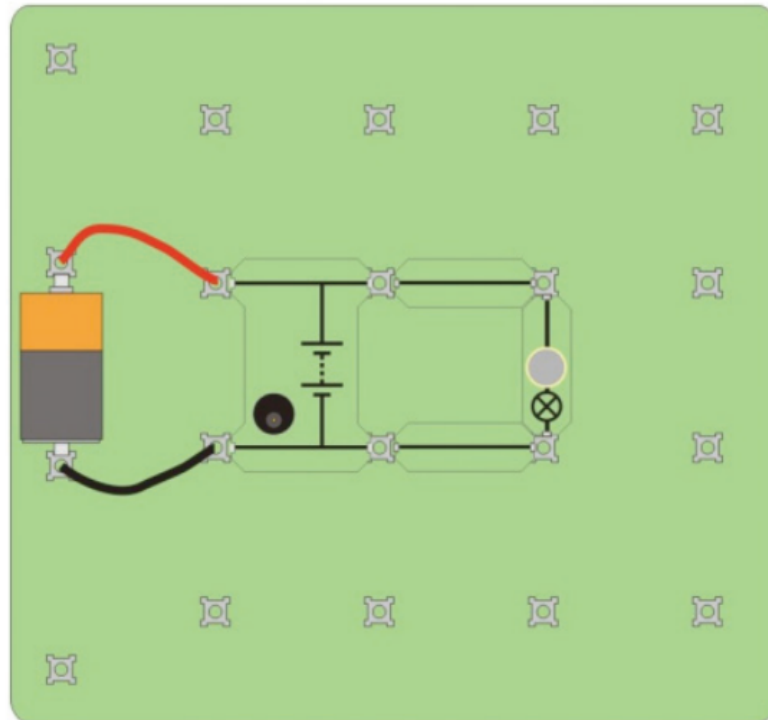

Activity:

Make a circuit like the one below, using a battery and a bulb.

- The electricity stored in the battery flows around the circuit and through the bulb making it light up.

Extension Activities

- Look at the battery closely.
- What do you think would happen if you removed the battery?

Warning: Never open a battery or put one in your mouth. The chemicals inside are poisonous

Worksheet 5

A complete circuit

A circuit needs 2 things to work:

1. A source of electricity. Without a battery there would be no electricity to make the bulb light up. 2. A complete circuit. There must be no gaps in the circuit or the electricity stored in the battery would not be able to flow all the way around the circuit

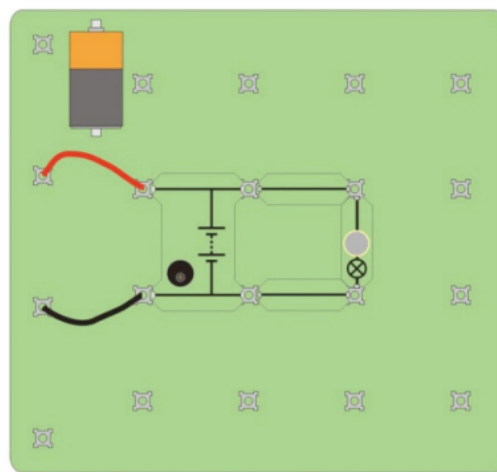
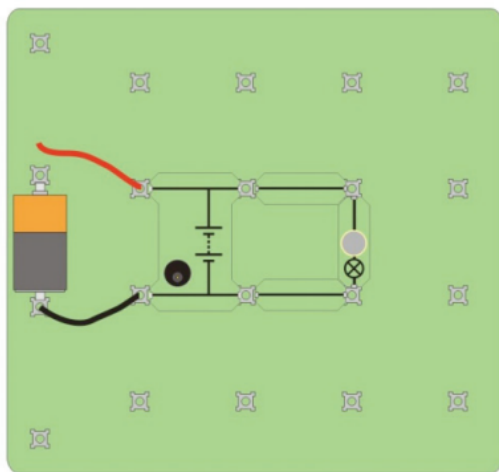

Activity:

- Make a working circuit using a battery and a bulb.
- Remove the battery from the circuit.
- What happens?
- Remove a lead from the battery. What happens?
- In how many different ways can you make the light bulb go out?
- Record your ideas and try them out.
- What does this tell you about electrical circuits?

When the bulb lights up, it proves that the circuit is working correctly

Activity:

- Make a circuit using a battery and a bulb.

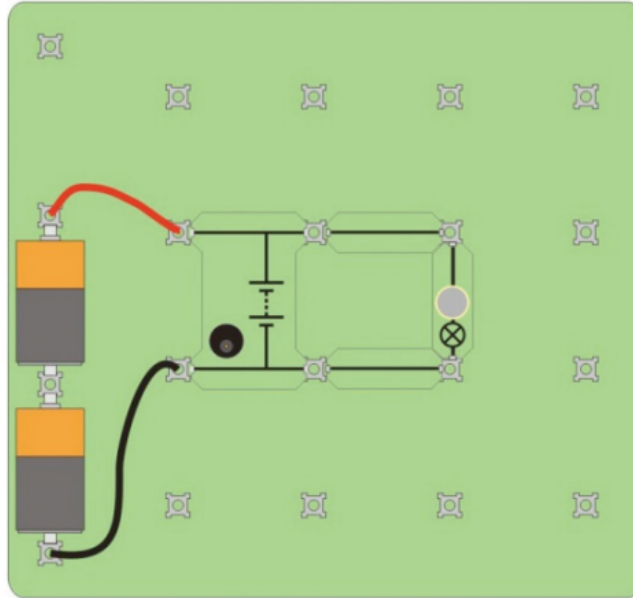

- Trace the path of electricity with your finger.
- What happens if you reverse the battery?
- Does the bulb light up differently?
- What does this tell you about batteries and bulbs?
- Write down all your answers.

Extension Activity

- Look carefully at the bulb in your circuit and draw what you see.
- When electricity passes through the filament in the bulb, it glows bright and gets hotter.
- Explain why it would be harder to check if the circuit was working if the filament was broken.

Batteries

Batteries come in all different shapes and sizes depending on what we want to use them for. They must be inserted correctly (with the positive and negative ends the right way around) in order for the electrical appliance to work. If we increase the number of batteries, then we increase the amount of electricity flowing around the circuit.

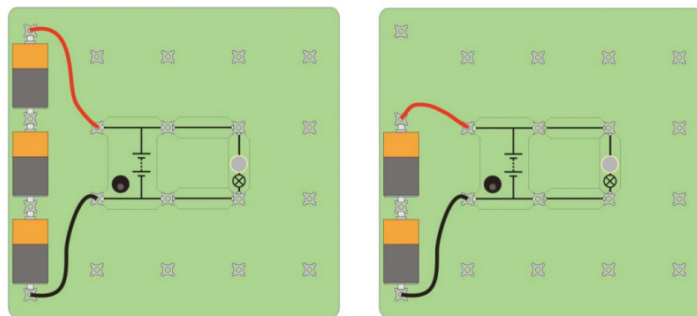

Activity

- Make a circuit using two batteries and a bulb.
- Make a note of what you see.
- Add and remove batteries from the circuit.
- Experiment by reversing some of the batteries.
- Make 5 changes to the circuit and write down what effect each change has.
- What does this tell you about batteries?

Warning:

Adding too many batteries to a circuit may cause bulbs and other devices to burn out.

Buzzers

So far we have used a bulb as the electrical component in our circuit. When the bulb lights up this indicates that the circuit is working correctly. Another component that can be used in a circuit is a buzzer. When electricity passes through the buzzer it makes a loud noise. When you touch a buzzer you can feel it vibrate and it is this vibration that produces the sound.

Activity:

- Make a circuit using a battery and a buzzer
- Reverse the buzzer
- What do you notice?
- Draw a picture of your working circuit.
- What do you notice about the way a buzzer works?

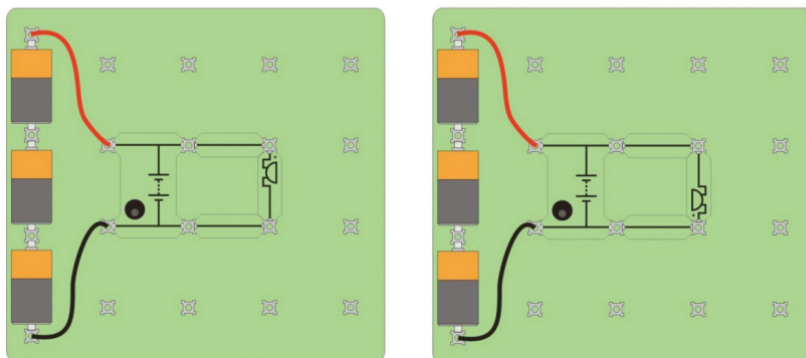

Extension Activity

- Can you make the buzzer louder and quieter?
- Make 5 changes to your circuit and write down what effect each change has.
- Think about all the electrical appliances that make a sound, like a doorbell for example and list all the others you can think of

Motors

Motors are used to power all sorts of things that we use everyday. Motors work when we pass electricity through them, in the same way bulbs and buzzers work. You can reverse the direction in which the cog on the motor is spinning by swapping the poles of the battery.

Activity:

- Make a circuit using a battery and a motor
- .Look at the motor to see if it is spinning.
- Try reversing the battery connectors and watch what happens
- Write down what has changed

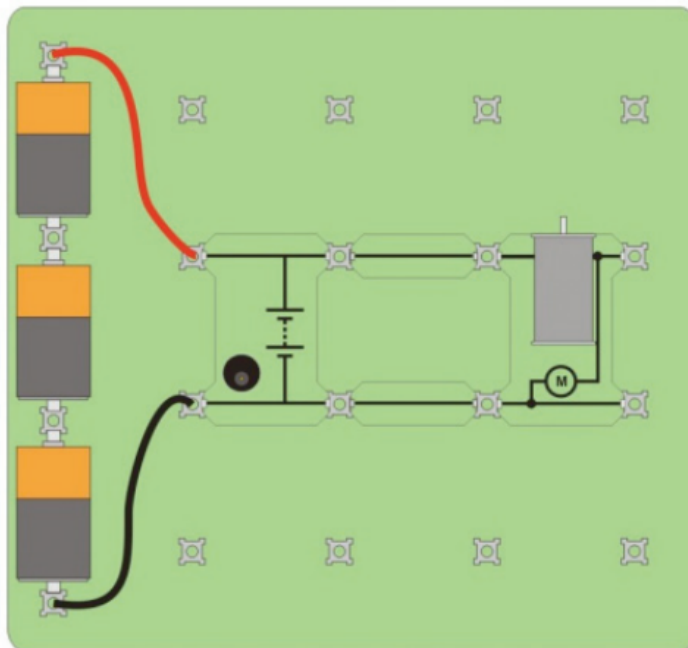

Extension Activity

- Think about what other devices use a motor and make a list.
- Imagine a new invention that you have created that uses a motor. Draw what it would look like and describe how it would work.

Conductors

Some materials allow electricity to pass through them. These materials are called conductors because we say that they conduct electricity. Metals are usually very good conductors but some metals are better conductors than others. If a material does not conduct electricity then we say it is an insulator

Activity:

- Make a circuit using components shown below
- We will use the leads with crocodile clips to see if a material conducts electricity or not
- Touch the crocodile clips together. Very fine metal wires run through the leads allowing us to pass electricity through them completing the circuit.

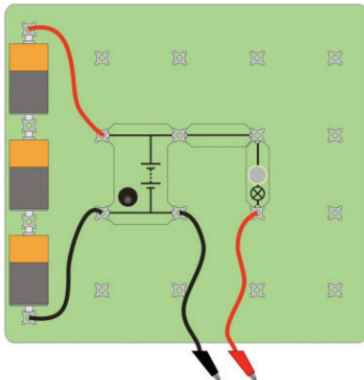

- Collect some objects to see if they will conduct or not. Attach a crocodile clip to each end of your objects and see if the bulb lights up. Complete this table or copy it into your book.

What is the object?	Does the bulb light it up?	Is it a conductor?	Is it an insulator?

Conductors and Insulators

Most metals are good conductors of electricity. The leads in your circuit have thin metal wires running through them allowing electricity to pass from one end of the lead to the other. The connecting links in your circuit have a metal strip underneath to allow electricity to pass through them.

Other materials that do not conduct electricity are called insulators. Insulators can be used to protect us from electricity. Plastic is wrapped around wires to protect them and keep the electricity inside.

Water is also very good conductor of electricity. Electricity should never be used near water and this is why there are never any light switches or plug sockets in bathrooms.

It may also seem strange that air can act as an insulator which stops electricity jumping. Overhead electricity lines are insulated in air. However if you make contact with the lines then there is no insulator between you and the electricity. The electricity can then jump straight into you! Never touch electricity cables.

Activity:

Look at these images. Explain what is happening in each photo and what the dangers are.

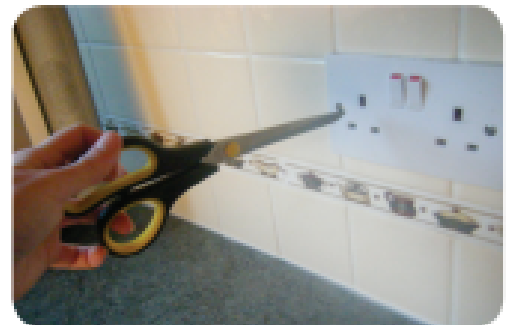
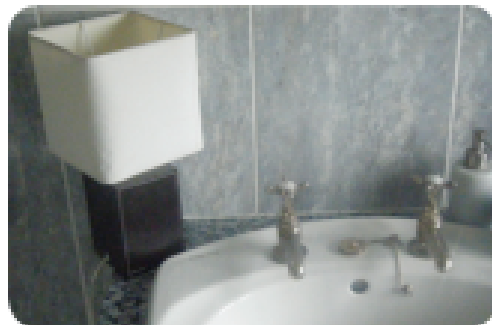

Extension Activity

Extension Activity:

L	A	S	T	R	K	L	M	P	Y	G	R	E	N	E
I	C	O	N	D	U	C	T	O	R	R	S	R	Y	L
G	I	K	G	D	Z	O	D	E	T	E	W	J	F	E
H	F	B	W	R	C	P	S	G	L	O	I	X	D	C
T	Q	B	U	Z	Z	E	R	R	U	R	R	T	H	T
N	A	S	F	N	M	G	U	F	M	N	G	J	H	R
I	D	X	Y	R	E	T	T	A	B	V	F	D	P	I
N	Q	W	S	V	B	N	Y	U	B	J	B	L	G	C
G	B	R	C	E	I	N	S	U	L	A	T	O	R	I
P	U	G	H	N	M	S	F	R	Y	B	X	C	B	T
S	L	F	G	J	A	S	E	C	T	G	H	L	P	Y
E	B	R	Y	S	C	V	B	Y	I	U	N	M	A	S
J	E	Q	H	W	I	R	E	S	S	R	D	V	N	L
V	C	S	W	I	R	U	T	Y	I	M	C	Y	U	U
T	Q	E	W	T	F	G	H	L	P	Z	A	U	V	N
A	A	X	R	C	U	V	B	R	B	N	X	B	I	B
E	M	A	M	H	T	D	T	G	M	E	J	E	S	T
H	Y	M	B	Q	D	L	I	G	H	T	X	K	D	R

Can you find all the electrical words in the word search below?

ELECTRICITY CIRCUIT
ENERGY SWITCH
MOTOR BULB
CONDUCTOR HEAT
BUZZER LIGHT
BATTERY WIRES
INSULATOR LIGHTNING

Once you have found the words, write a short description explaining what each word means. Use books, the internet and work sheets to help you.

Switches

A switch can be used to stop or continue the flow of electricity around the circuit. Use either a slide switch or a press switch to build the circuit below

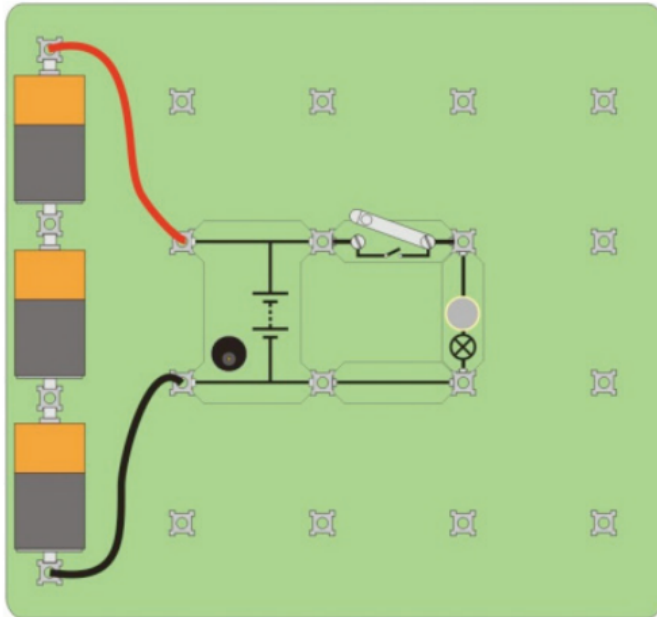

Activity:

- Make the circuit with an open switch. Does the circuit work?
- Now close the switch. What happens?
- Explain why this is happening.
- Try putting your switch in different places in the circuit.
- Does this have any effect?

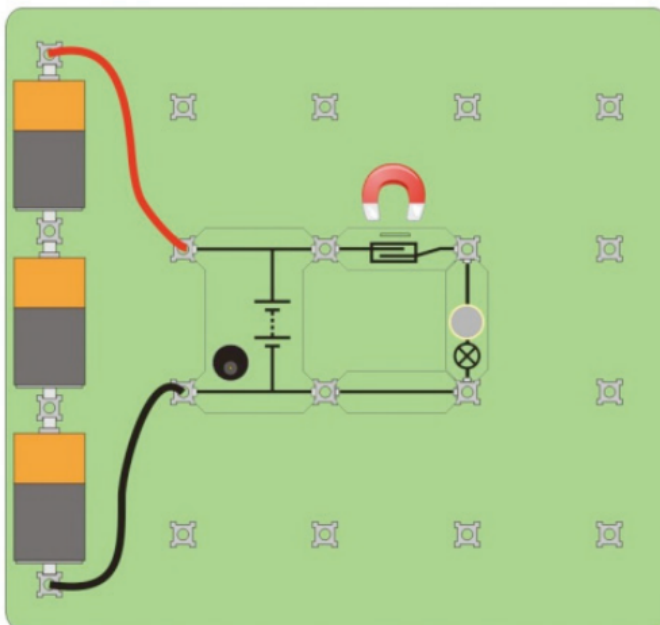

Reed Switches

Now try a reed switch. Inside a reed switch there are thin magnetic reeds which conduct electricity. Normally these reeds do not touch and so electricity cannot flow through the switch, and the circuit is broken. Try moving a magnet towards the reed switch. If the magnet is strong enough the reeds inside the switch will become magnetically charged and pull towards each other. This allows the electricity to flow through the switch.

Components in a circuit

12. Components in a circuit

The electricity from a battery can be shared between components and so adding more components (like bulbs and buzzers) to a circuit can affect what these components do. If a bulb has to share electricity then it may not shine as bright. What do you think will happen to a buzzer if it has to share electricity?

Activity:

- Make a circuit with 3 batteries and a bulb
- Look at the polarity of the batteries to make certain that all batteries are pushing in the same direction
- Predict and write down what you think will happen if you add another bulb to the circuit. Try it ... was it what you expected?

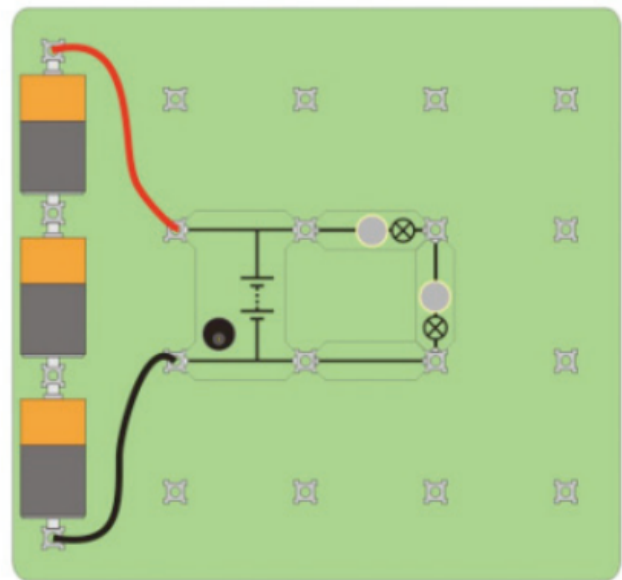
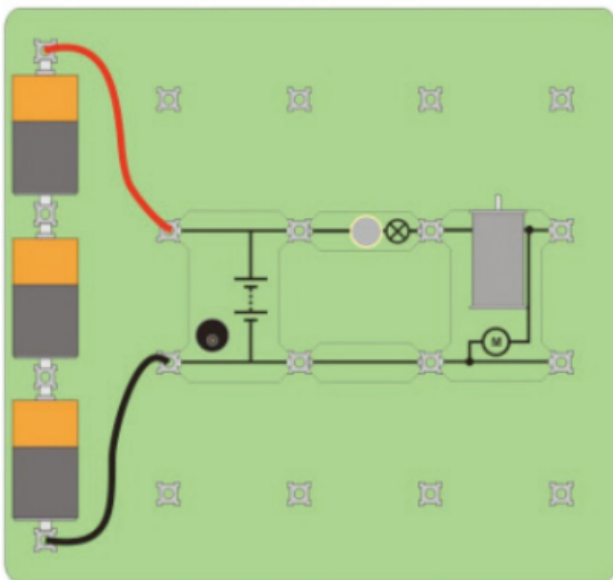

- Explain why this is happening and draw your circuit to illustrate your reasons Further Investigations

Further Investigations

- Now replace a bulb with a motor.
- What happens?
- Replace the motor with a buzzer. What happens?
- What effect is the bulb having on the other components?
- What effect are the other components having on the bulb?











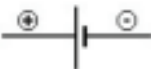

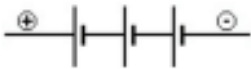

Warning: Adding too many batteries to a circuit may cause too much electricity to pass through components, burning them out.

Circuit symbols

You may have noticed the symbols on the Locktronics carriers you are using to build your circuits. These are called circuit symbols and help us to understand how the circuit should work. They also help us to draw diagrams of the whole circuit.

Activity:

- Symbols are used in circuit diagrams which show how a circuit is connected together.
- The actual layout of the components can be different to the diagram so long as all the components are connected to the circuit.
- Look at all the components and their symbols

Name:	Symbol:	Locktronics:
Single Battery		
Triple Battery		
Wire Connector		
Bulb		
Switch		
Motor		
Buzzer		

- Look at the following diagrams and describe what they do.

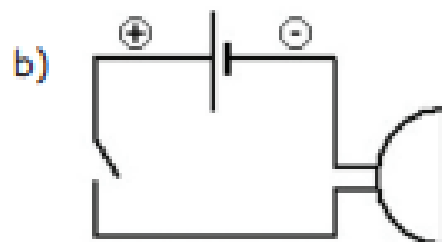
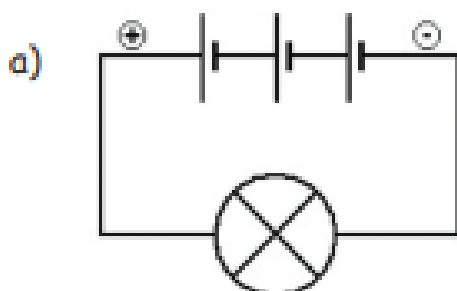

- Draw the picture of the circuit. Is it easier to draw a picture of the circuit or to draw the diagram?

Circuit diagrams

We can connect circuit symbols together to make circuit diagrams. These diagrams help us to design a circuit before we build it. We can also build circuits based on what we see in the circuit diagram.

Activity:

- Draw the circuit diagrams from the following pictures and describe what they do.

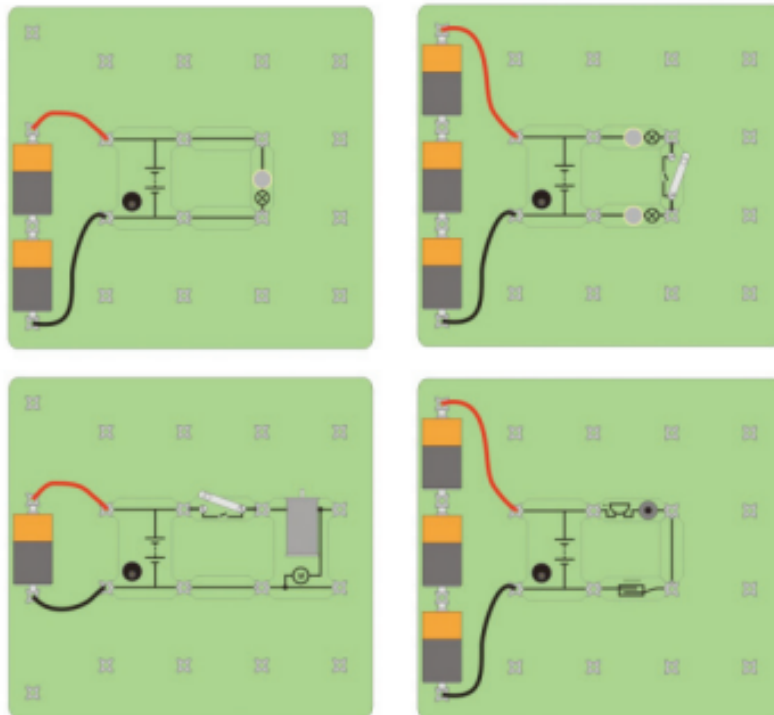

- Look at the diagrams below. Write down what will happen in each circuit.
- Construct the circuits from the diagrams and check your predictions

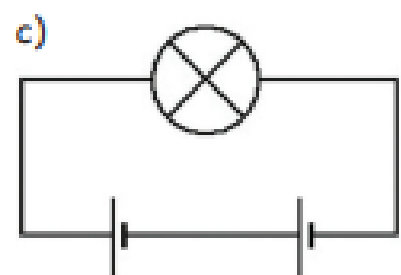
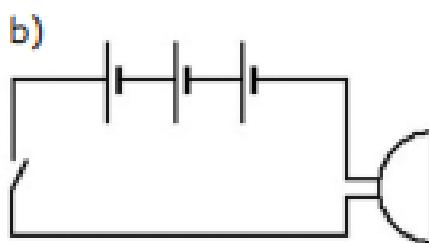
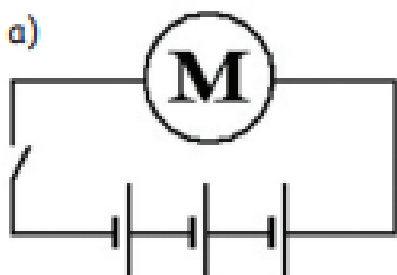

Types of Circuit

There are two common types of circuit. Parallel circuits and Series circuits.

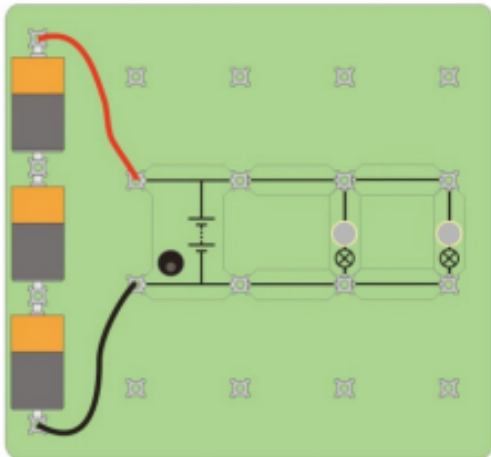

Activity:

- Construct a circuit using three batteries and a bulb
- Using the same batteries, make the circuit below so that both bulbs light up.
- This is known as a parallel circuit. The components are in series (in this case the bulbs) run parallel to each other. The electricity must flow through both components in order to complete the circuit.

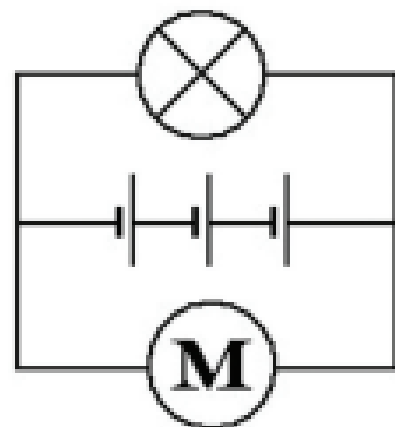

Construct the circuit from the diagram below. This is a series circuit. The bulbs are in series because they share the same connection to the battery. The electricity must flow through both components in order to complete the circuit.

- Draw the circuit diagrams in your book and explain why they are either series or parallel.

Extension Activities

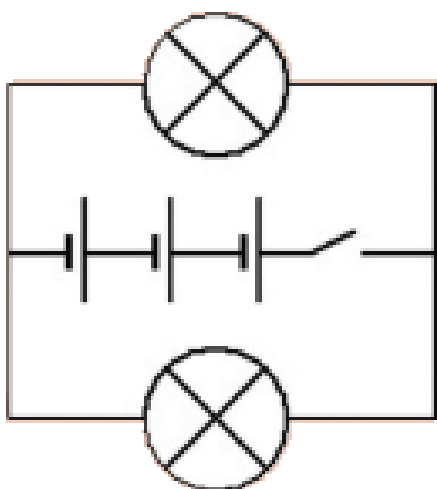

- Can you add a switch to the circuit so that the switch will turn both bulbs off.
- Replace one bulb with a buzzer making sure the buzzer is connected the correct way around. What happens?
- Now change the buzzer for a motor. What happens to the bulb and the motor?
- Draw the circuit diagrams for your circuits with buzzers and motors. Explain what happens when you open and close the switch.

Electricity

We have looked at how electricity is all around us and is necessary for almost everything we do.

Activity: • Imagine a world without electricity • Write a short story explaining how this is different to the world we live in and all the good and bad changes that there would be • The pictures below may help you with ideas



Technology



Weapons



Healthcare



Power



Heat



Communications



Fun and games



Light

Extension Activity: a) Would you rather live in a world with or without electricity? Explain your answer. b) Would a world without electricity be more or less dangerous than the world we live in? Think about how dangerous electricity can be but also think about all the dangers that electricity protects us from. (e.g. Fire alarms need electricity to work)

Understanding circuits

17. Understanding Circuits • So far you have learnt how batteries, bulbs and components in a circuit work. You have also learnt the difference between conductors and insulators.

Activity: • Look at these circuits. Write down if they will work and if not, why?

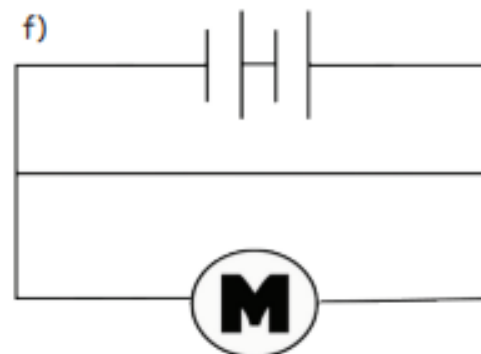
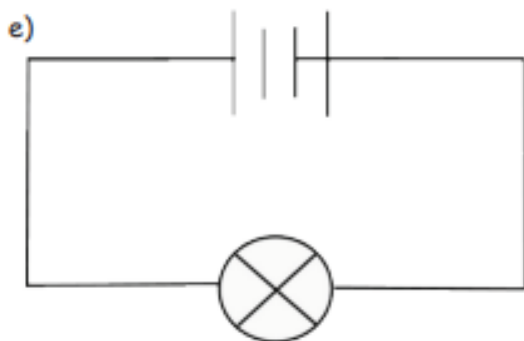
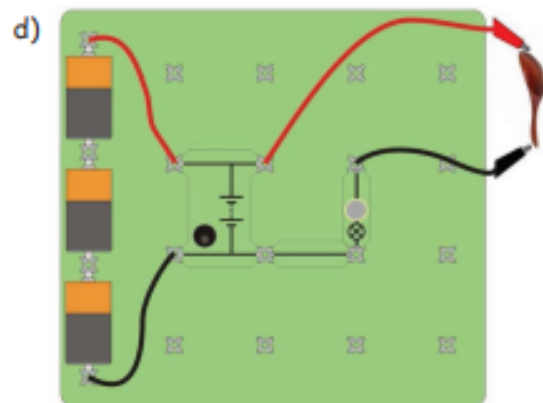
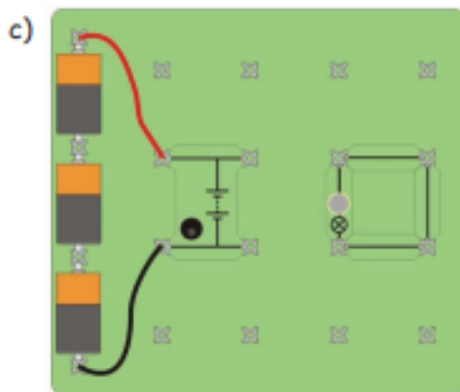
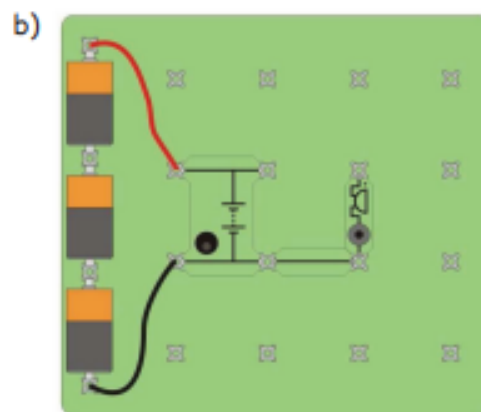
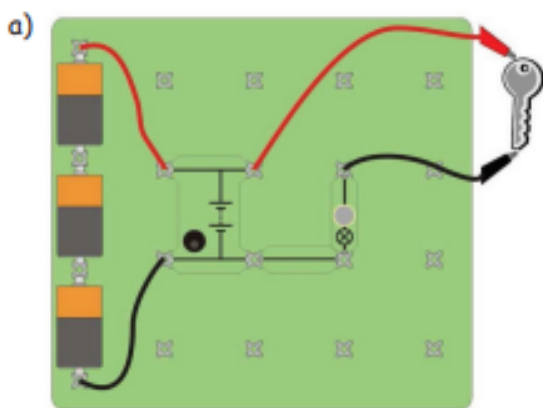

Fundamentals of Electricity

The Locktronics Fundamentals of Electricity teaching solution has been designed specifically for UK Key Stages one and two but will be useful at an introductory level with all students of electricity.

The level of understanding escalates over the course of the worksheets which can be used as a series or individually to compliment existing lesson plans. Units 2F, 4F and 6G are comprehensively covered within this curriculum pack.

There is particular emphasis on cross curricula learning throughout these worksheets and pupils will develop an understanding of electricity, whilst enhancing their literacy, ICT, technological, artistic and experiential learning skills. They should also develop an awareness of the dangers of electricity as they further appreciate its use in the modern world around us.

Each worksheet has accompanying teacher's notes which identify the required learning objectives and offer guidance on tackling key principles. Pupil understanding of the topic area can be assessed through a number of both written and experimental exercises that can be done as a class or in small groups or pairs.

Solution Contents:

- 9 x Connecting Link
- 3 x Lampholder carriers
- 1 x Pair red and black leads
- 1 x Press Switch
- 1 x Slide switch
- 1 x Buzzer
- 1 x Motor
- 3 x MES Bulbs
- 1 x Magnet
- 1 x Curriculum Pack CD ROM
- 1 x Power supply carrier with battery symbol
- 1 x International power supply
- 1 x Pair of crocodile clip leads
- 1 x Reed switch
- 1 x Baseboard with battery retaining clips
- 1 x Storage tray with lid, daughter tray, foam

WORKSHEET NOTES AND ANSWERS INTRODUCTORY NOTES

1. What is Electricity?
2. Teaching Electricity
3. The Locktronics Fundamentals of Electricity Kit
4. Using the Worksheets

WORKSHEETS:

1. Which things use Electricity? - Pupils develop an understanding of which things use electricity and how they use it i.e. to produce heat, light, sound etc. To extend the exercise you can add images or real devices from the classroom and ask children to discuss the proposed questions.
2. Types of Electricity - Children should know the difference between natural electricity and man-made electricity. Cross curricular use of a PC and the internet are encouraged but children can use books or other resources. Understanding of the differences between batteries and mains electricity is developed. Make use of electrical devices in the classroom to reinforce the activities where possible.
3. Electricity can be Dangerous - Understand that electricity is a form of power that is both useful and dangerous. Children are asked to design a danger poster thinking about what they have seen before. Cross Curricular Art and Design and ICT skills can be incorporated into the lesson. 'Fill in the blanks' answers: 1. off 2. wet 3. power 4. kite 5. chemicals. Talk through the dangers that electricity presents with the class without generating an unnecessary degree of fear. Worksheet 16 encourages children to also consider the dangers that electricity protects us from. You may feel that it is appropriate to use both worksheets together.
4. Making a Circuit - Introducing pupils to the Locktronics range as a means of building circuits. Children develop the understanding of batteries as an energy source and grasp what is needed to complete a working circuit. Bulbs, as a component can be used as a means of testing if the circuit works.
5. A Complete Circuit - Children test their ideas about what may stop a circuit from working developing their knowledge of what a good circuit requires. Introduces pupils to an experiential way of learning. They test their own predictions and record their findings. The extension activity reinforces these principles.
6. Batteries - Gain a greater understanding of batteries and how they work. Children are introduced to polarity and again experiential learning is encouraged.

7. Buzzers - We substitute a bulb for a buzzer as the electrical component in the circuit and means of illustrating to children that the circuit is working. The notion of polarity is reinforced with the buzzer. Note that the buzzer will only work if batteries are connected the right way round with the 'positive' to the red lead. You may want to introduce devices that make a sound to the class and ask them to suggest how they

8. Motors - We now use a motor as the electrical component in the circuit. In the extension activity children are asked to design and draw a new invention using a motor. You are free to decide the most appropriate way in which to conduct this cross-curricular science and technology experiment, extending the exercise where possible considering time, resources and required learning outcomes.

9. Conductors - You may want to provide the resources needed to conduct this experiment or allow pupils to find their own. The introduction of conductors and insulators may be difficult for pupils to grasp but this experiential activity will help them to grasp the differences by testing conductivity themselves.

10. Conductors and Insulators - Largely an information based worksheet to ease children through the understanding of conductors and insulators. This is combined with assessing the safety implications for each. In the activity children are asked to spot and discuss the obvious dangers.

L	A	S	T	R	K	L	M	P	Y	G	R	E	N	E	ELECTRICITY
I	C	O	N	D	U	C	T	O	R	R	S	R	Y	L	ENERGY
G	I	K	G	D	Z	O	D	E	T	E	W	J	F	E	MOTOR
H	F	B	W	R	C	P	S	G	L	O	I	X	D	C	CONDUCTOR
T	Q	B	U	Z	Z	E	R	R	U	R	R	T	H	T	BUZZER
N	A	S	F	N	M	G	U	F	M	N	G	J	H	R	BATTERY
I	D	X	Y	R	E	T	T	A	B	V	F	D	P	I	INSULATOR
N	Q	W	S	V	B	N	Y	U	B	J	B	L	G	C	CIRCUIT
G	B	R	C	E	I	N	S	U	L	A	T	O	R	I	SWITCH
P	U	G	H	N	M	S	F	R	Y	B	X	C	B	T	BULB
S	L	F	G	J	A	S	E	C	T	G	H	L	P	Y	HEAT
E	B	R	Y	S	C	V	B	Y	I	U	N	M	A	S	LIGHT
J	E	Q	H	W	I	R	E	S	S	R	D	V	N	L	WIRES
V	C	S	W	I	R	U	T	Y	I	M	C	Y	U	U	LIGHTNING
T	Q	E	W	T	F	G	H	L	P	Z	A	U	V	N	
A	A	X	R	C	U	V	B	R	B	N	X	B	I	B	
E	M	A	M	H	T	D	T	G	M	E	J	E	S	T	
H	Y	M	B	Q	D	L	I	G	H	T	X	K	D	R	

11.Switches - The activity asks students to use a switch, illustrating the effects of a break in a circuit. The reed switch is quite different as an example of the range of switches that can be used. A detailed explanation of a reed switch is provided to aid understanding but further explanation may be required.

12.Components in a Circuit - The effects of multiple components in a circuit are tested in worksheet 12. Children are encouraged to test their own ideas at this stage and record their findings. Additional components from the Locktronics range could be used if available.

13.Circuit Symbols – Pupils are introduced to the concept of circuit symbols and the reasons why they are necessary. The Locktronics carriers reinforce this. a) has three batteries and a bulb b) one battery, with a buzzer and a switch.

14.Circuit Diagrams – Explains the notion that a collection of symbols make a circuit diagram. You may need to devise further exercises to reinforce and assess understanding following the activities in the worksheet.

15.Types of Circuit – An introduction to series and parallel circuits. Children will require support when embarking on this worksheet. Think of additional ways you can reinforce the notion of ‘series’ and ‘parallel’ before moving on to the activities.

16.Electricity - A cross-curricular story writing activity encouraging children to consider the advantages and disadvantages of electricity. Enables you to assess both their understanding of the subject area and their ability to present these ideas in a literary sense.

17. Understanding circuits – Can be used as an assessment activity or done in pairs.

Circuit (a) the metal key conducts electricity

Circuit (b) needs a link to complete the circuit

Circuit (c) the bulb is detached from the power supply

Circuit (d) the wooden spoon is an insulator

Circuit diagram (e) shows batteries pushing in opposite directions

Circuit diagram (f) indicates a short circuit

1. WHAT IS ELECTRICITY?

Electricity plays a very important part in our lives. It is used to light up our homes, cook the food we eat, power our games consoles and TVs, as well as allowing many other crucial devices that are essential to our everyday lives to function. Electricity can best be described as energy travelling down a wire. A good way of illustrating this is to refer to Newton's Cradle ...

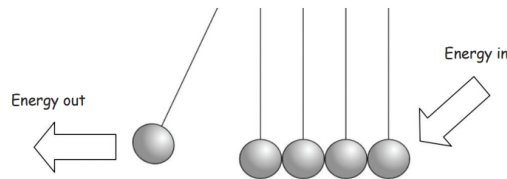

When the ball on one end is pulled aside and allowed to swing and strike the remaining balls, the outcome is that the one ball on the far end is knocked away from the others and all of the other balls remain at rest. This shows that energy can travel in objects, without the objects themselves having to move.

Electricity is the flow of electrical power.

2. ELECTRICITY IS ESSENTIAL FOR EVERYDAY LIFE

To achieve a good knowledge and understanding of electricity, what it does and how to use it, certain key principles need to be understood. These include:

- Everyday appliances use electricity to make them work.
- Electricity is essential to everyday life.
- Mains electricity is extremely hazardous and that appliances connected to the mains must be used safely.
- Some devices use batteries to generate electricity and these can be handled safely.
- A complete circuit including a battery is needed to make simple devices work.
- Most metals are good conductors of electricity, most other materials are insulators.
- Electricity will not flow if there is a break in the circuit and that a switch can be used to make or break a circuit.
- Understand the different effects of placing batteries in a circuit.

3. THE FUNDAMENTALS OF ELECTRICITY KIT

The Fundamentals of Electricity kit is designed for groups of children to explore and experiment with a range of components. They should be encouraged to...

- Construct and test a range of circuits.
- Make their own predictions.
- Suggest and record observations.
- Explain outcomes.
- Articulate the dangers of coming into contact with mains electricity'

4. USING THE WORKSHEETS

The worksheets are designed to be used with the Fundamentals of Electricity kit. They are a resource of ideas and activities for the teacher to consider using with children. It is not necessary to work through the sheets in numerical order. They are however designed to progress from simple concepts to more complex ideas. It is suggested, that the teacher selects the sheets and activities most suited to pupils experience, level and ability and uses them to inform their own lesson planning.

- Sheets 1 to 3 begin with the notion that electricity is all around us. It is useful and can perform many tasks. It can however be very dangerous and children need to be aware of the dangers.
- Sheets 1 to 8 introduce the idea of a circuit and the many different components that are available. They consider the effects of different components and the need for a complete circuit to make electricity flow.
- Sheet 9 to 10 develops the notion of conductors and insulators. They remind children that electricity is all around and to be aware of the dangers.
- Sheets 11 to 13 extend the range of components, outlines the effects components have on each other and the concepts of resistance to electrical flow.
- Sheets 14 to 15 deal with circuit diagrams. Children are able to read, follow and construct circuits from diagrams, and be able to draw diagrams for others to follow.
- Sheet 16 building on circuit diagrams, introduces for the first time parallel circuits and its effect upon components.
- Sheets 17 to 18 offer the teacher ideas for assessing pupil knowledge and understanding of the key principles. It needs to be pointed out that assessment should be a continuous process and not simply a test at the end of a course.

The kit and the worksheets provide the teacher with a resource that can support good teaching. Together they can help children develop a better understanding of electricity, its uses, its dangers and how it works and behaves. But perhaps the most important aspect it provides is the opportunity for children to explore for themselves and find out from first hand experiences how electricity works.

If you are using these worksheets as an introduction and are wishing to develop your understanding of electricity, the next step up in the Locktronics range would be the 'Electricity, Magnetism and Materials' kit with curriculum packs 'Electricity Matters 1 and 2'.

Using the power supply and battery symbol carrier You will notice that you have a choice when deciding on the most appropriate way of powering your circuit.

BATTERIES: The battery retaining clips on the baseboard give you the option to use batteries to power your circuit. You can then use leads to extend from the batteries, to either:

- a) The pillars directly before the connecting links feeding electricity into the circuit.
- b) Alternatively in order to maintain the circuit diagram, fix the leads from the batteries to either of the pairs of pillars either side of the battery symbol carrier.

You will notice that the diagrams in this curriculum pack follow suggestion b. This prevents the break in the circuit diagram, supporting the development and understanding

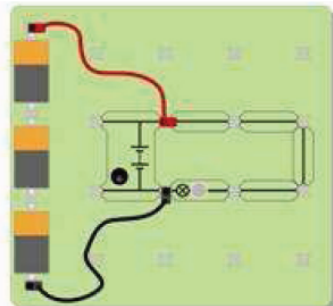
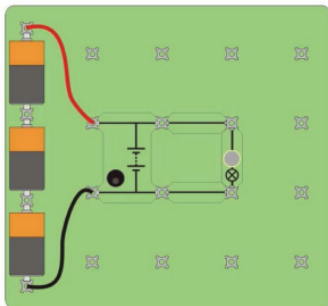

of electricity. However students may point out that the carrier itself bearing the symbol is not the actual source of electricity and so some explanation may be required.

POWER SUPPLY:

If you would prefer to use a power supply to power your circuit, plug your power supply into the mains (ensuring that students are aware of the dangers of working with mains electricity), use the key to set your power supply to the right voltage, and insert your power supply into the battery symbol carrier. This is a cheaper and possibly more efficient way of powering the circuit, however your students may again point out that the battery symbol on the carrier does not refer to

a battery but rather a source of electricity. This system maintains the circuit diagram whilst removing the need for batteries, but may again require some explanation.

