

**MATRIX**

# **EBLOCKS<sup>®</sup>**

PICmicro<sup>®</sup> MCU multiprogrammer

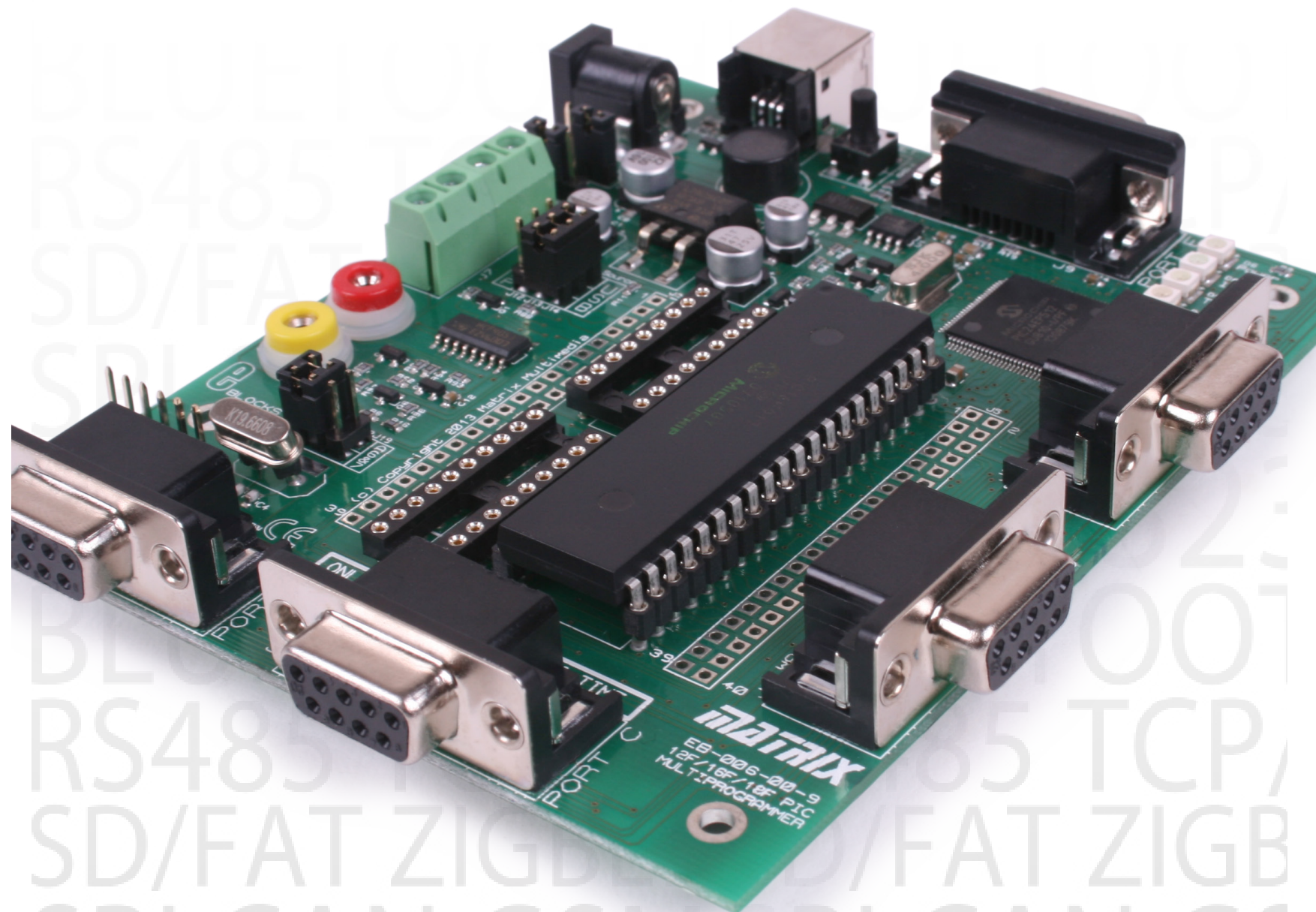

[www.matrixtsl.com](http://www.matrixtsl.com)

EB006V9

# Contents

About this document	3
General information	4
Board layout	5
Circuit description	6
Protective cover	7
PICmicro microcontroller pin out details	8
Bus connections	9
Circuit diagram	11

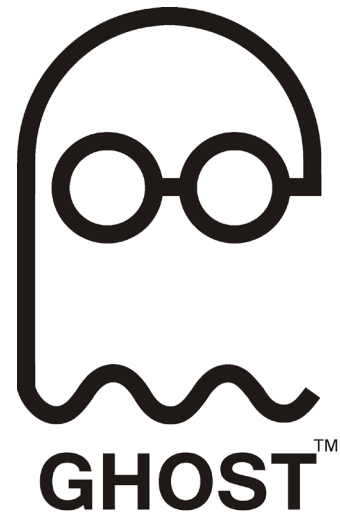



# About this document

This document concerns the EB006V9 E-blocks PICmicro multiprogrammer board (version 9).

## 1. Trademarks and copyright

PIC and PICmicro are registered trademarks of Arizona Microchip Inc. E-blocks is a trademark of Matrix Technology Solutions Ltd.

## 2. Disclaimer

The information provided within this document is correct at the time of going to press. Matrix TSL reserves the right to change specifications from TSL to time.

## 3. Testing this product

It is advisable to test the product upon receiving it to ensure it works correctly. Matrix provides test procedures

for all E-blocks, which can be found in the Support section of the website.

## 4. Product support

If you require support for this product then please visit the Matrix website, which contains many learning resources for the E-blocks series. On our website you will find:

- How to get started with E-blocks - if you are new to E-blocks and wish to learn how to use them from the beginning there are resources available to help.
- Relevant software and hardware that allow you to use your E-blocks product better.
- Example files and programs.
- Ways to get technical support for your product, either via the forums or by contacting us directly.

# General information

The EB006 V9 PICmicro microcontroller programmer connects to your PC via USB to provide you with a low cost and flexible PICmicro microcontroller programmer. This board can be used with conventional microcontroller programs that generate hex code for the PIC family: MPLAB, C compilers, BASIC compilers etc. The EB006 V9 has many features that are optimised for use with Flowcode version 6 including Ghost technology.

The board will program most 8, 14, 18, 20, 28 and 40 pin flash PICmicro microcontroller devices using the free 'mLoader' programming software provided. mLoader can be downloaded from the Matrix web site.

The board also provides 'clean' access to all Input/Output lines on the relevant PICmicro microcontroller device. These are presented on 9 way D-type connectors: 8 bits and earth. A range of additional E-blocks boards can plug into these D-type connectors to provide a rapid prototyping system for learning and development.

More information on Ghost technology can be found on our website at [www.matrixtsl.com/ghost](http://www.matrixtsl.com/ghost).

## 1. Features

- E-blocks compatible
- Low cost
- Used as a programmer and as a development board
- Programs a wide range of PICmicro MCU devices
- Full suite of programming software available
- Ghost technology included
- Removable crystal oscillator source
- 5 I/O ports
- In-Circuit Debugging via PICKIT2 connector
- In-Circuit Debug with Flowcode 6
- In-Circuit Test with Flowcode 6
- Charge pump capability to allow high voltage programming from USB supply
- 2mm power connector sockets
- Powerful 16bit host chip with Ghost technology operating system included
- All pins on target device monitored by host microcontroller
- On-board SRAM memory for data storage
- LEDs for Power, In-Circuit -Debug, In-Circuit -Test, and Program
- Lower operating voltage (9V)

# General information

## 2. Block schematic

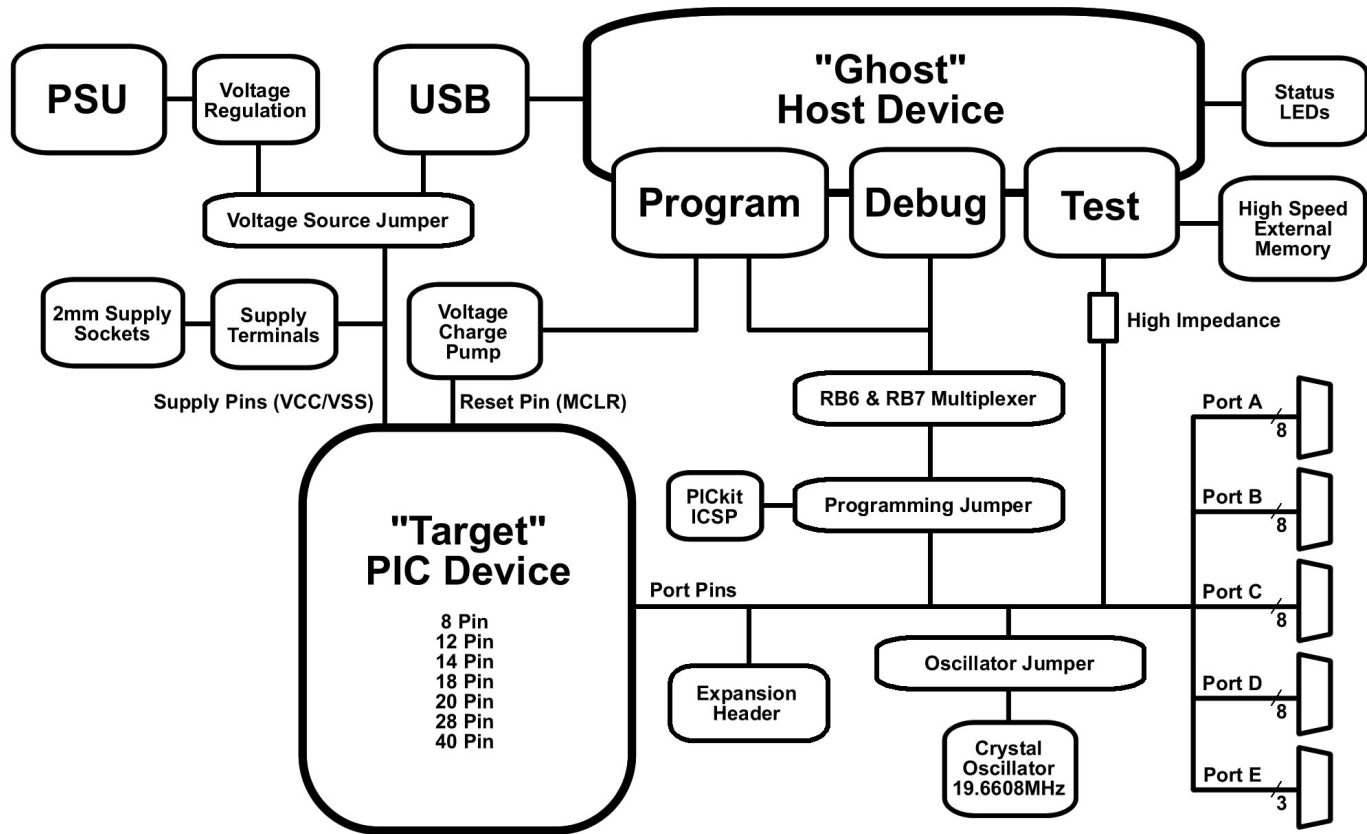

## 3. Support devices

Currently mLoader and the EB006V9 support the following PICmicro devices:

### 12F Devices

PIC12F609, PIC12F615, PIC12F617, PIC12F629, PIC12F635, PIC12F675, PIC12F683, PIC12F752

### 16F Devices

PIC16F1516, PIC16F1517, PIC16F1518, PIC16F1519, PIC16F1526, PIC16F1526, PIC16F1782, PIC16F1783, PIC16F1823, PIC16F1824, PIC16F1825, PIC16F1826, PIC16F1827, PIC16F1828, PIC16F1829, PIC16F1847, PIC16F1933, PIC16F1934, PIC16F1936, PIC16F1937, PIC16F1938, PIC16F1939, PIC16F1946, PIC16F1947, PIC16F610, PIC16F616, PIC16F627A, PIC16F627, PIC16F628A, PIC16F628, PIC16F630, PIC16F631, PIC16F636, PIC16F639, PIC16F648A, PIC16F676, PIC16F677, PIC16F684, PIC16F685, PIC16F687, PIC16F688, PIC16F689, PIC16F690, PIC16F72, PIC16F720, PIC16F721, PIC16F737, PIC16F73, PIC16F747, PIC16F74, PIC16F767, PIC16F76, PIC16F777, PIC16F785, PIC16F77, PIC16F818, PIC16F819, PIC16F84A,, PIC16F870, PIC16F871, PIC16F872, PIC16F873A, PIC16F873, PIC16F874A, PIC16F874, PIC16F876A, PIC16F876, PIC16F877A, PIC16F877, PIC16F87, PIC16F88, PIC16F882, PIC16F883, PIC16F884, PIC16F886, PIC16F887, PIC16F913, PIC16F914, PIC16F916, PIC16F917, PIC16F946

### 18F Devices

PIC18F242, PIC18F248, PIC18F252, PIC18F258, PIC18F442, PIC18F448, PIC18F452, PIC18F458, PIC18F1220, PIC18F1230, PIC18F1231, PIC18F1320, PIC18F1330, PIC18F1331, PIC18F13K50, PIC18F14K50, PIC18F2220, PIC18F2221, PIC18F2320, PIC18F2321, PIC18F2331, PIC18F23K20, PIC18F23K22, PIC18F2410, PIC18F2420, PIC18F2423, PIC18F2431, PIC18F2439, PIC18F2450, PIC18F2455, PIC18F2458, PIC18F2480, PIC18F24K20, PIC18F24K22, PIC18F24K50, PIC18F2510, PIC18F2515, PIC18F2520, PIC18F2523, PIC18F2525, PIC18F2539, PIC18F2550, PIC18F2553, PIC18F2580, PIC18F2585, PIC18F25K20, PIC18F25K22, PIC18F2610, PIC18F2620, PIC18F2680, PIC18F2682, PIC18F2685, PIC18F4220, PIC18F4221, PIC18F4320, PIC18F4321, PIC18F4331, PIC18F43K20, PIC18F43K22, PIC18F4410, PIC18F4420, PIC18F4423, PIC18F4431, PIC18F4439, PIC18F4450, PIC18F4455, PIC18F4458, PIC18F4480, PIC18F4510, PIC18F4515, PIC18F4520, PIC18F4523, PIC18F4525, PIC18F4539, PIC18F4550, PIC18F4553, PIC18F4580, PIC18F4585, PIC18F4586, PIC18F45K20, PIC18F45K22, PIC18F4610, PIC18F4620, PIC18F4680, PIC18F4681, PIC18F4682, PIC18F4685, PIC18F46K20, PIC18F46K22

# Board layout

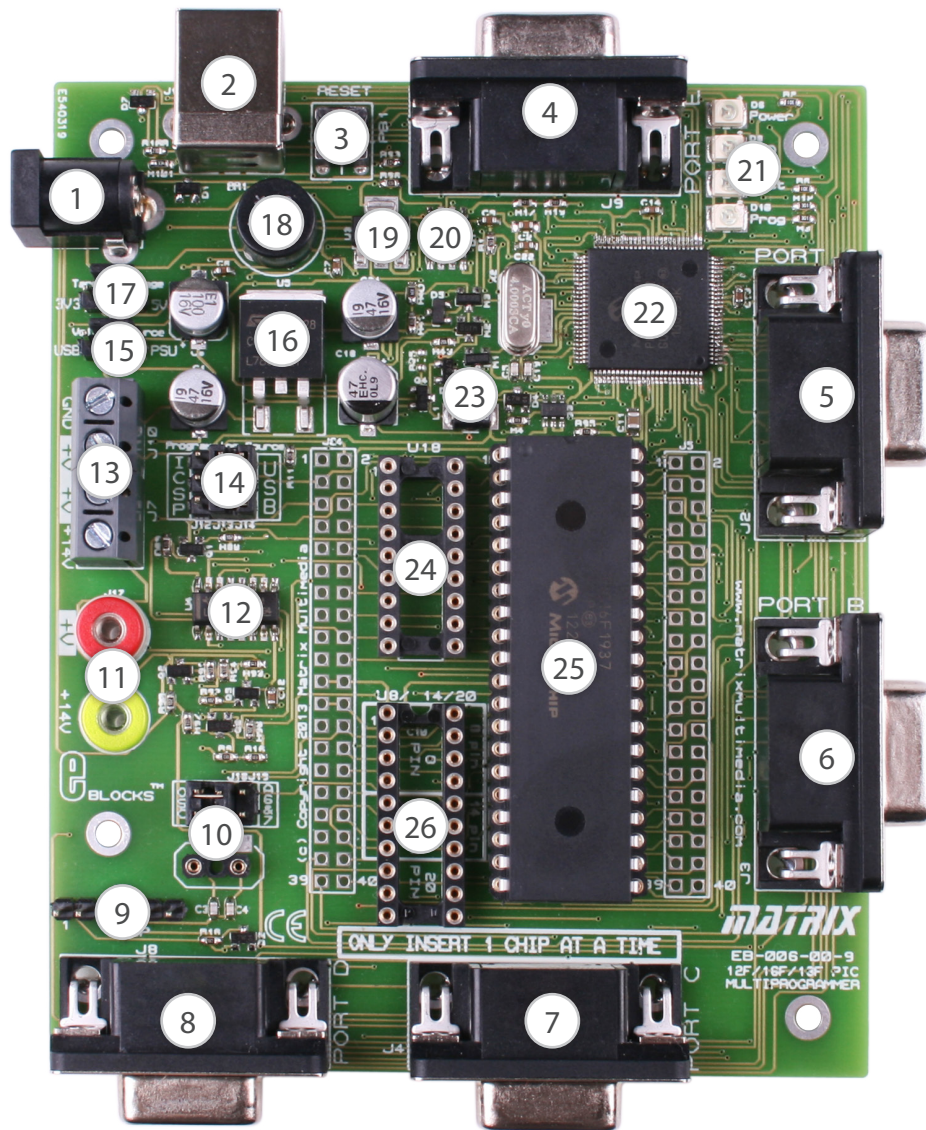

- |  |  |
|--|--|
| <ol style="list-style-type: none"> <li>1. Power connector - either polarity 7.5 – 9V</li> <li>2. USB connector</li> <li>3. Reset switch</li> <li>4. Port E I/O</li> <li>5. Port A I/O</li> <li>6. Port B I/O</li> <li>7. Port C I/O</li> <li>8. Port D I/O</li> <li>9. PICKit ICSP Header</li> <li>10. Removable crystal / oscillator pin assignment jumper</li> <li>11. 2mm sockets for supplying power to downstream E-block boards</li> <li>12. Analogue switch to allow programming and debug pins to be connected / disconnected from circuit</li> <li>13. Power screw terminals</li> </ol> | <ol style="list-style-type: none"> <li>14. USB/ICSP programming selector</li> <li>15. USB/PSU power selector</li> <li>16. 5V voltage regulator</li> <li>17. 3V3/5V VDD voltage selector</li> <li>18. Bridge rectifier</li> <li>19. 3V3 voltage regulator</li> <li>20. SRAM storage IC</li> <li>21. Status LEDs, Power, ICD, Test, Program</li> <li>22. Powerful host microcontroller</li> <li>23. Charge pump circuitry</li> <li>24. Turned pin DIL socket for 18 pin PICmicro devices</li> <li>25. Turned pin DIL socket for 28 and 40 pin PICmicro devices / 40 pin 16F1937 Target Microcontroller (supplied)</li> <li>26. Turned pin DIL socket for 8, 14, 20 pin PICmicro devices</li> </ol> |
|--|--|

# Circuit description

The multiprogrammer solution is made up of two parts: a circuit board that allows various slave PICmicro devices to be programmed, and the Windows based programming utility 'mLoader'.

## 1. Power supply

The board is normally operated from a regulated DC supply of 7.5 - 9V or from a USB supply. This allows full operation including programming. The board can be operated solely from the USB cable provided. However care must be taken, as there is only limited power that can be taken from a computer's USB port.

The jumper link system, J11, allows the user to decide on the source of the power supply. If using a regulated 7.5V power supply the jumper should be positioned to the right hand side of the jumper system labeled 'PSU'. If using USB power place the jumper on the left hand side of the jumper system. LED D6 indicates that power is correctly supplied to the board.

Please note that both USB and the PSU cables should be removed for the Multiprogrammer board BEFORE changing the position of this jumper.

Remember that other E-blocks will have to receive their voltage by placing a connecting wire from the "+V" screw terminal of the Multiprogrammer to the "+V" screw terminal of each E-Block that requires a voltage.



**WARNING:** Take extra care when wiring in a power supply 12V may cause the board to run hot.

## 2. Programming circuit

The Multiprogrammer connects to a personal computer via the USB socket. Any USB socket on the PC can be used. The host microcontroller is used to communicate between the USB bus and the Multiprogrammer circuitry. The host is connected to a network of analogue switches formed by U4 and a charge pump circuit which is used to multiply the operating voltage up to the 9-12V programming voltage. This circuitry routes 0V, VDD and VPP to appropriate pins on the slave PICmicro devices as and when necessary.

## 3. DIL sockets and I/O ports

The slave PICmicro DIL sockets are wired in parallel (see table of connections below) and the ports are fed out to 5 D-type sockets grouped in ports. These signals are also

available on a 40-way header (J5) for expansion purposes. Other important signals can be accessed via the other expansion header J24 (see table of connections below). Port E has only 3 connections, which reflects the pin outs of the various PICmicro devices themselves. When using an 8-pin or 14-pin device it should be placed in the upper pins of the 20-pin DIL socket as marked on the board. Please refer to device datasheets for availability of port outputs on each device.

**NOTE:** RA4 on some PICmicro devices has an open collector output. This means that you will most likely need a pull up resistor to be able to drive an LED etc. Please see the datasheet on the device you are using for further details. (Does not apply to 16F1937 device supplied with the board).

**WARNING:** Only fit one PICmicro device at a time. Inserting more than one PICmicro device will cause programming to fail and may even cause damage to the board or the PICmicros.



## 4. Reset push button

PB1 provides a reset by pulling the MCLR pin low. Note that the programming chip will reset the slave PICmicro as part of the send routine so that you do not need to press this switch each time you send your program to the board. If you are using a device with internal MCLR functionality then you will have to ensure that the chip is configured with an external MCLR to allow the reset operation to work. Devices using the internal MCLR configuration setting will be able to use the reset switch as a digital input.

## 5. Frequency selection

By default the board is fitted with a 19.6608MHz crystal. The crystal fits into a small socket, which allows the crystal to be easily changed. For older Matrix TSL courses a 3.2768MHz crystal is recommended. These frequencies are chosen as they divide down by PICmicro prescalers to give suitable frequencies for clock systems and for facilitating serial communication using standard baud rates.

The Jumper link system J18, J19 allows PICmicro devices with internal oscillators to route the signals from the oscillator pins through to Port A pins 6 and 7. This allows the devices with internal oscillators to use all 8-bits of the Port A for I/O operation.



## 6. In-Circuit Debugging

The Multiprogrammer board has an in-circuit debugging (ICD) connection between the USB peripheral device and the target microcontroller. This allows the Flowcode software to start, stop, step and inspect an active program, synchronized both in hardware and Flowcode 6 software. As well as the standard ICD operation, Flowcode is capable of reading back real time variable values from the target device.

To use the Microchip PICkit2 ICSP interface, remove the power supply and the USB cable from the Multiprogrammer. Then place the 3-way jumper link associated with J12-14 to the left hand side of the 3 x 3 header pins, labeled 'ICSP'. Then simply connect the PICkit into the Multiprogrammer via header J20.

## 7. In-Circuit Test

The Multiprogrammer board has an in-circuit test (ICT) connection between the USB peripheral device and all of the target microcontroller's I/O pins. This allows the

Flowcode 6 software to monitor all of the signals on the board in either analogue or digital modes.

The in circuit test feature can be combined with packet decoding to allow data and control busses to be explored and debugged

## 8. Low voltage programming

Many PICmicros have a low voltage programming mode where it is possible to program the device without the need for a 12V supply line or charge pump. The difficulty here is that different families of PICmicro devices use different pins as the Low Voltage programming pin. B3 is predominantly used for this function but B4 and B5 are also used on some devices. For this reason the version 9 EB006 does not support low voltage programming modes so care must be taken when generating the chip configuration to disable the low voltage programming functionality. If the low voltage programming configuration is left enabled then you will not be able to use the LVP pin as an I/O pin in your application.

# Protective cover

Most of the boards in the E-blocks range can be fitted with a plastic cover as an optional extra. These covers are there to protect your E-blocks board therefore extending the life of the board. The covers also prevent the removal of external components while still allowing for the adjustment of applicable parts on the board.

12mm M3 spacers, anti-slip M3 nuts and 25mm M3 bolts can be used to attached the cover to the board. These are not included but can be bought separately from our website.

The order code for the EB006 PICmicro® MCU microcontroller cover is EB706.

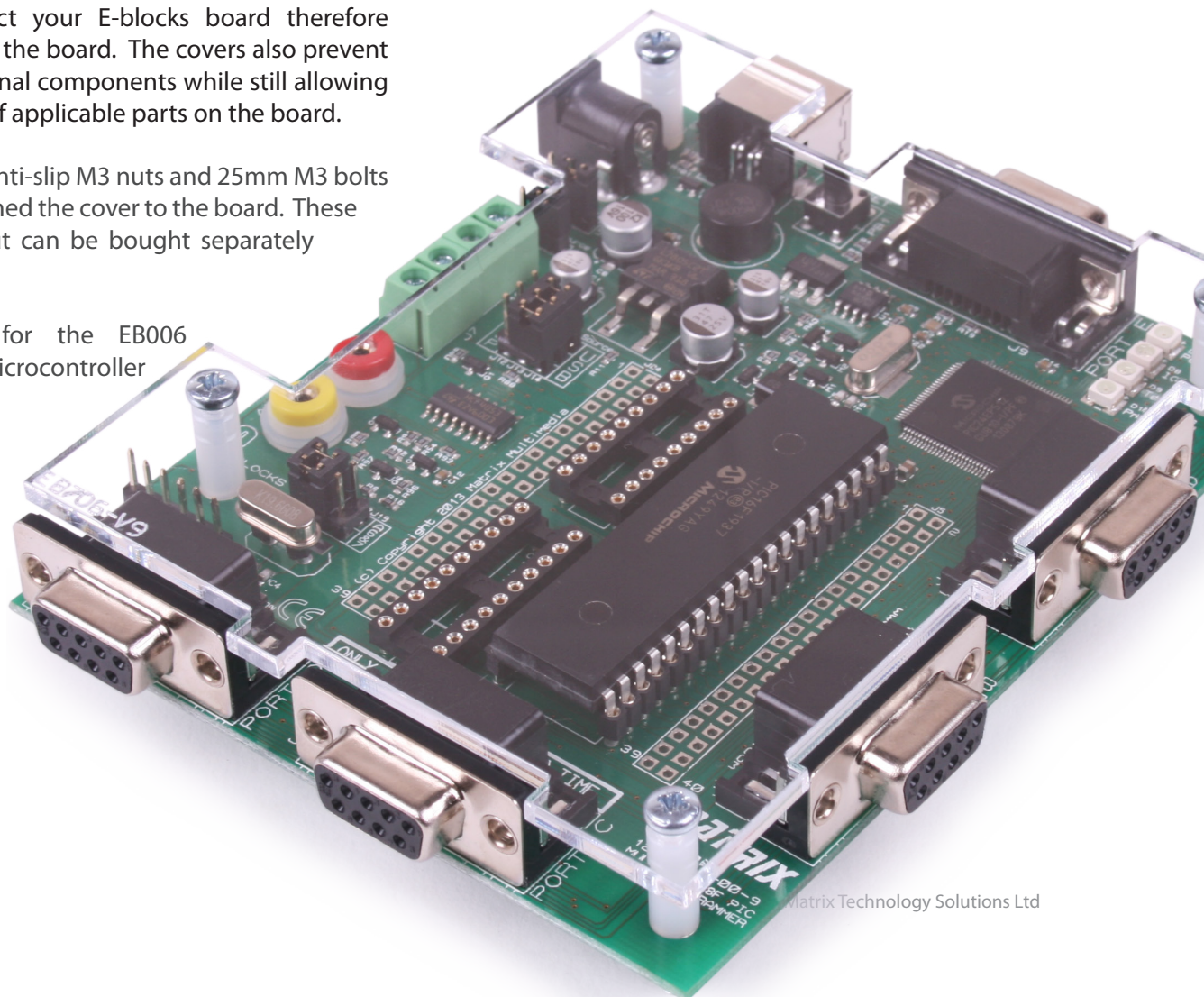

# PICmicro microcontroller pin out details

Broadly speaking the ranges of PICmicro devices are designed to be upwards compatible: the pin functions on an 18-pin device are available on a 28-pin device and a 40-pin device. This can be seen from the following

excerpt from the Microchip product selector card. The following diagram shows the pin out of the various PICmicro devices:

## 18-pin PICmicro

RA2/AN2/Vrefout	1	18	RA1/AN1
RA3/AN3/CMP1/Vrefin	2	17	RA0/AN0
RA4/T0CKI/CMP2	3	16	OSC1/CLKIN/RA7
Vpp/RA5/THV/MCLR	4	15	OSC2/CLKOUT/RA6
Vss	5	14	Vdd
RBO/INT	6	13	RB7/T1OSI
RB1/RX/DT	7	12	RB6/T1OSO/T1CKI
RB2/TX/CK	8	11	RB5
RB3/CCP1	9	10	RB4/PGM

## 20-pin PICmicro

Vdd	1	20	Vss
RA5/OSC1/CLKIN	2	19	RA0/D+/PGD
RA4/AN3/OSC2/CLKOUT	3	18	RA1/D-/PGC
RA3/MCLR/Vpp	4	17	VUSB
RC5/CCP1/P1A	5	16	RC0/AN4/INT0/VREF+
RC4/P1B	6	15	RC1/AN5/INT1/VREF-
RC3/AN7/P1C/PGM	7	14	RC2/AN6/INT2
RC6/AN8/T1OSCO	8	13	RB4/AN10/SDI/SDA
RC7/AN9/SDO/T1OSCO	9	12	RB5/AN11/RX/DT
RB7/TX/CK	10	11	RB6/SCK/SCL

## 28-pin PICmicro

Vpp/MCLR	1	28	RB7/PGO/KB13
RA0/AN0	2	27	RB6/PGC/KB12
RA1/AN1	3	26	RB5/KB11
RA2/AN2/Vrl/Vref-	4	25	RB4/KB10
RA3/AN3/Vrh/Vref+	5	24	RB3/PGM/CCP2/CANRX
RA4/T0CKI	6	23	RB2/INT2/CANTX
RA5/AN4/SS/Avdd/Lvdin	7	22	RB1/INT1
Vss	8	21	RB0/INT0
OSC1/CLKI	9	20	Vdd
OSC2/CLKO/T1CKI	10	19	Vss
RC0/T1OSO/CCP2I	11	18	RD7/PSP7/PD
RC1/T1OS/CCP2I	12	17	RD6/PSP6/PC
RC2/CCP1	13	16	RD5/PSP5/PB
RC3/SKC/SCL	14	15	RD4/PSP4/ECC/PA

## 8-pin PICmicro

Vdd	1	8	Vss
GP5/OSC1/CLKIN	2	7	GP0/AN0
GP4/OSC2/AN3/CLKOUT	3	6	GP1/AN1/Vref
Vpp/GP3/MCLR	4	5	GP2/T0CKI/AN2/INT

Note that GP0 maps to RB7  
GP1 maps to RB6  
GP2/AN2 maps to RA0/AN0

## 14-pin PICmicro

Vdd	1	14	Vss
RA5/T1CKI/OSC1/CLKIN	2	13	RA0/CIN+/ICSPDAT
RA4/TIG/OSC2/CKLOUT	3	12	RA1/CIN-/ICSPCLK
RA3/MCLR/Vpp	4	11	RA2/COU/T0CKI/INT
Rc5	5	10	Rc0
Rc4	6	9	Rc1
Rc3	7	8	Rc2

## 40-pin PICmicro

MCLR	1	40	RB7/PGO/KB13
RA0/AN0	2	39	RB6/PGC/KB12
RA1/AN1	3	38	RB5/KB11
RA2/AN2/Vrl/Vref-	4	37	RB4/KB10
RA3/AN3/Vrh/Vref+	5	36	RB3/PGM/CCP2/CANRX
RA4/T0CKI	6	35	RB2/INT2/CANTX
RA5/AN4/SS/Lvdin	7	34	RB1/INT1
RE0/AN5/RD	8	33	RB0/INT0
RE1/AN6/WR	9	32	Vdd
RE3/AN7/CS	10	31	Vss
Avdd	11	30	RD7/PSP7/PD
Avss	12	29	RD6/PSP6/PC
OSC1/CLKI	13	28	RD5/PSP5/PB
OSC2/CLKO/RA6	14	27	RD4/PSP4/ECC/PA
RC0/T1OSO/T1CKI	15	26	RC7/RX/DT
RC1/T1OSVCCP2	16	25	RC6/TX/CK
RC2/CCP1	17	24	RC5/SKO/D+
RC3/SCK/SCL	18	23	RC4/SDI/SDA/D-
RD0/PSP0/C1IN+	19	22	RD3/PSP3/C2IN
RD1/PSP1/C1IN-	20	21	RD2/PSP2/C2IN+



# Bus connections

## 1. Expansion bus

The pin connections on the expansion bus exactly mirror the pin numbering on the 40-pin DIL socket. Note that the pin numbering on the IDC socket is slightly different to that on a DIL socket which results in the seemingly odd arrangement of pins on the IDC pin chart.

PICmicro pinout						
Bus name	18 Pin	8 Pin	14 Pin	20 Pin	28 Pin	40 Pin
Vpp/MCLR	4	4	4	4	1	1
Vdd	14	1	1	1	20	11 & 32
Vss	5	8	77	20	8 & 19	12 & 31
OCS1	16	2	2	2	9	13
OCS2	15	3	3	3	10	14
RA0/AN0	17			19	2	2
RA1/AN1	18			18	3	3
RA2/AN2	1				4	4
RA3/AN3	2			4	5	5
RA4	3			3	6	6
RA5/AN4	4			2	7	7
RB0	6				21	33
RB1	7				22	34
RB2	8	5*	11*		23	35
RB3	9				24	36
RB4	10			13	25	37
RB5	11			12	26	38
RB6	12	6*	12*	11	27	39
RB7	13	7*	13*	10	28	40
RC0			10	16	11	15
RC1			9	15	12	16
RC2			8	14	13	17
RC3			7	7	14	18
RC4			6	6	15	23
RC5			5	5	16	24
RC6				8	17	25
RC7				9	18	26
RD0						19
RD1						20
RD2						21
RD3						22
RD4						27
RD5						28
RD6						29
RD7						30
RE0/AN5						8
RE1/AN6						9
RE2/AN7						10

For the 18, 28 and 40 pin devices the buses on devices are largely upwards compatible - pin connections on an 18-pin device appear on a 28-pin device and a 40-pin device, and pins on a 28-pin device appear on a 40-pin device. This allows the 18, 28 and 40 pin DIL sockets to be connected in parallel with the PICmicro bus structure intact.

\* This parallel connection is not possible with 8, 14 and 20 pin devices due to programming requirements which means that there are anomalies with the pin connections for the 8, 14 and 20 pin devices as follows:

Multiprogrammer port line	Connection pin on 20 pin device	20 pin port line
RB2	5	RA2
RB6	6	RA1
RB7	7	RA0

Multiprogrammer port line	Connection pin on 14 pin device	14 pin port line
RB2	5	RA2
RB6	6	RA1
RB7	7	RA0

Multiprogrammer port line	Connection pin on 8 pin device	8 pin port line
RB2	1	RA2
RB6	12	RA1
RB7	13	RA0

## 2. Connections on the IDC expansion connectors

Bus name	40 pin	J5 IDC connector	J24 IDC connector
Vpp/MCLR	1	1	2
VCCchip	11 & 32	18 & 21	21,22
GND	12 & 31	20 & 23	5
OCS1	13	25	26, 25
OCS2	14	27	28, 27
RA0/AN0	2	3	4
RA1/AN1	3	5	6
RA2	4	7	8
RA3/AN3	5	9	10
RA4/AN4	6	11	12
RA5	7	13	14
RB0	33	16	
RB1	34	14	
RB2	35	12	
RB3	36	10	35
RB4	37	8	
RB5	38	6	
RB6	39	4	37
RB7	40	2	39
RC0	15	29	30
RC1	16	31	32
RC2	17	33	34
RC3	18	35	36
RC4	23	36	
RC5	24	34	
RC6	25	32	
RC7	26	30	
RD0	19	37	38
RD1	20	39	40
RD2	21	40	
RD3	22	38	
RD4	27	28	
RD5	28	26	
RD6	29	24	
RD7	30	22	
RE0/AN5	8	15	16
RE1/AN6	9	17	18
RE2/AN7	10	19	20

Note: J5 is set to copy the 40-way DIL socket

# Circuit diagram

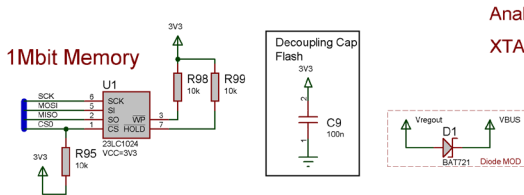
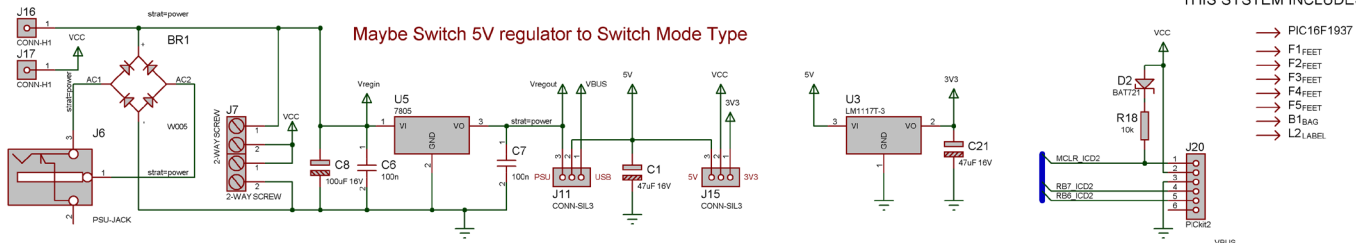

Analogue Channel To Monitor Current Usage?  
XTAL / RC Switch Slow / Fast - Still Needed?

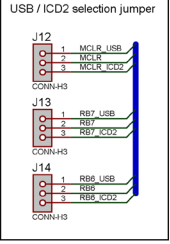
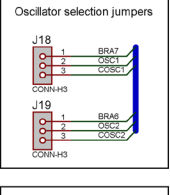
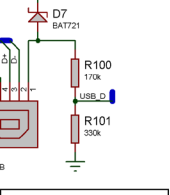
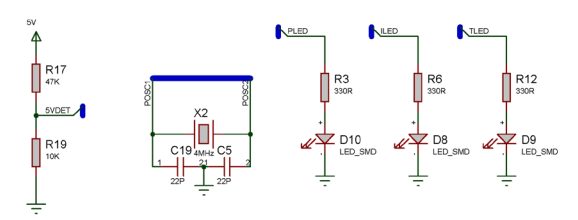
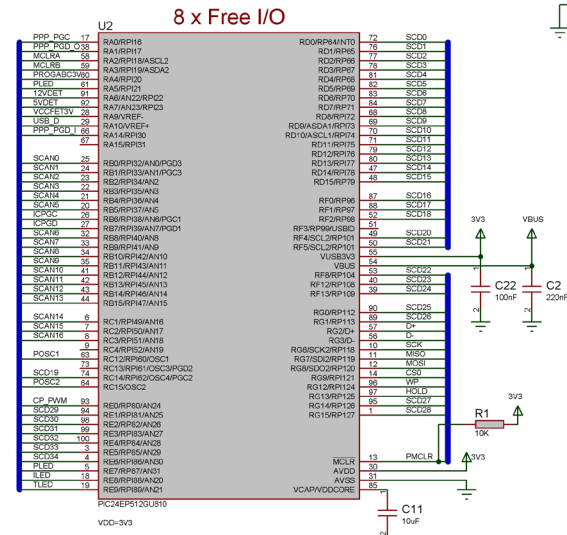

<b>MATRIX MULTIMEDIA LTD.</b> www.matrixmultimedia.com (c) Copyright 2012 Matrix Multimedia	
TITLE:	DATE:
EB006-00-9	08/03/13
E-Blocks Multiprogrammer Board	PAGE:
BY: B Rowland	REV: 9
	1/4

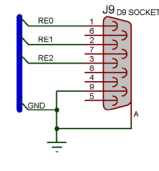
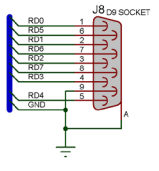
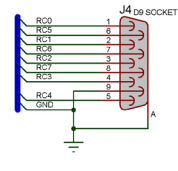
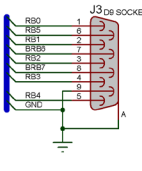
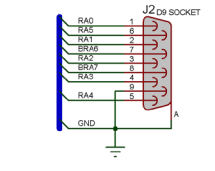
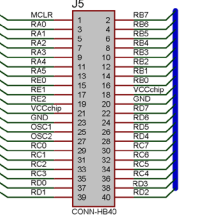
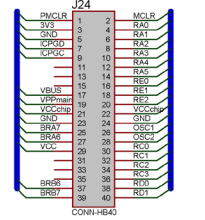
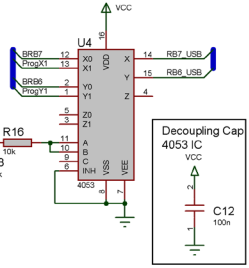
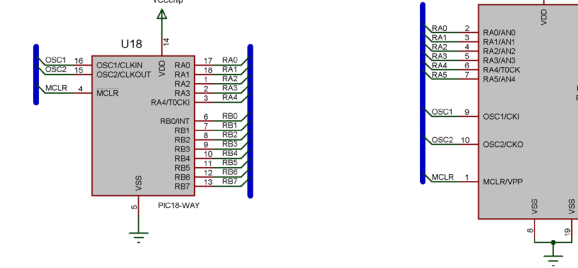
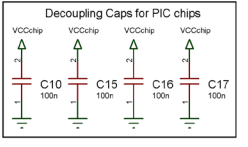
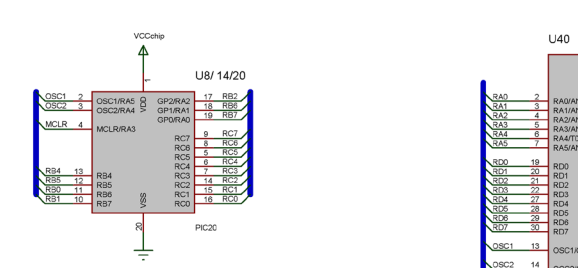
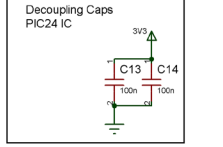

<b>MATRIX MULTIMEDIA LTD.</b> www.matrixmultimedia.com (c) Copyright 2008 Matrix Multimedia	
TITLE:	DATE:
EB006-00-8	08/03/13
Multiprogrammer PICmicro & I/O	PAGE:
BY: B Rowland	REV: 9
	2/4



# Circuit diagram

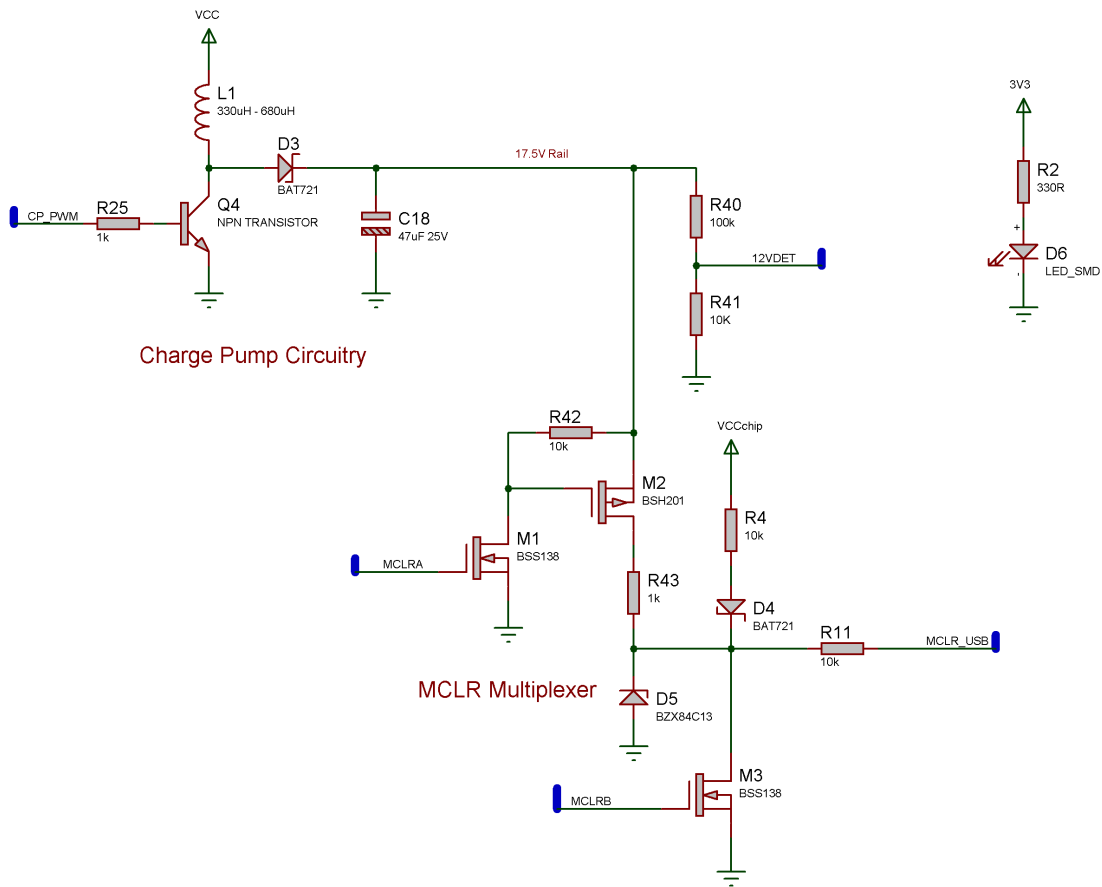

## Flowcode Test 17 X Analogue + 35 X Digital Traces

Analogue + Digital

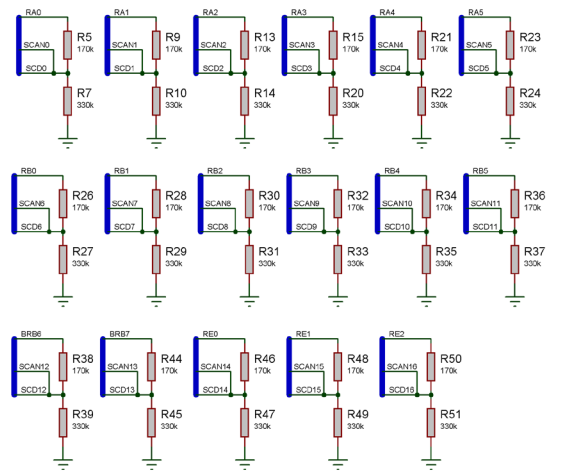

Digital

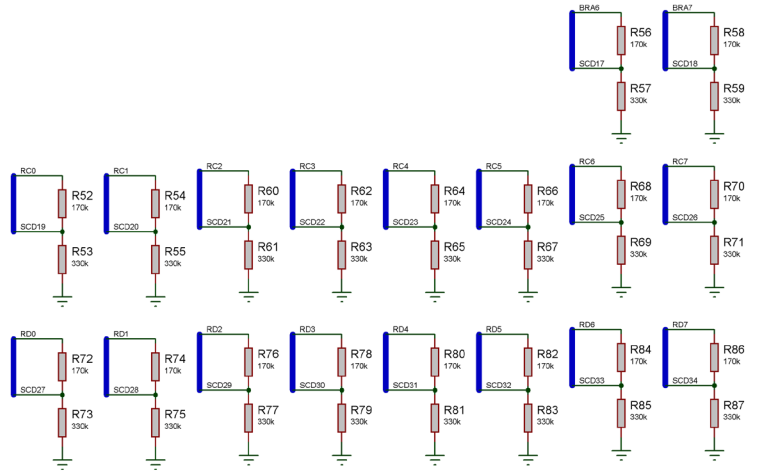

## Programming Pins Voltage Level Shifting

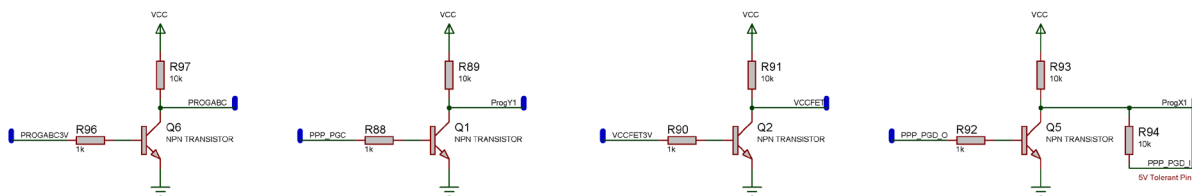



Matrix Technology Solutions Ltd.  
The Factory  
33 Gibbet Street  
Halifax, HX1 5BA, UK

t: +44 (0)1422 252380  
e: sales@matrixtsl.com

[www.matrixtsl.com](http://www.matrixtsl.com)

EB006-30-9